



C30X0-G10F-PTL-08

MS-IMU30X0 8 Inch

Unterminated Interface Cable

Document Number: DOC00476

Document Revision: A

Product Part Number: MP00063-003

Product Revision: B

MEMSENSE.COM

888.668.8743

Information provided herein is considered accurate however is not guaranteed. Memsense reserves the right to change specifications at any time, without notice.

Document Change History

REV	STATUS	DESCRIPTION	DATE
A	Release	Initial release.	8-23-16

Information provided herein is considered accurate however is not guaranteed. Memsense reserves the right to change specifications at any time, without notice.

1.0 SPECIFICATION

Table 1 – Cable Specifications

IMU Connector Mfg.	Harwin
IMU Connector Housing	G125-2041096L0
Contacts	G125-0020005
Encapsulant	Stycast 2651, Catalyst 9
Overall Length	8 inches
Tinned Length	0.125
Cable Mfg.	Microflex Wire & Cable
Cable PN	BN103025FEPUSIL
Cable Jacket	Silicone Rubber
Cable OD	0.115 inches
Wire Gauge	AWG 30
Wire Insulation	FEP

Table 2 – Pinout Signals

Pin No.	Wire Color	Signal Name
1	Red	PWR
2	No Connect	No Connect
3	Orange	1PPS
4	Green	RCV A
5	White	RCVB
6	Black	GND
7	Violet	TOV
8	Brown	X TRIG
9	Yellow	TX Y
10	Blue	TX Z

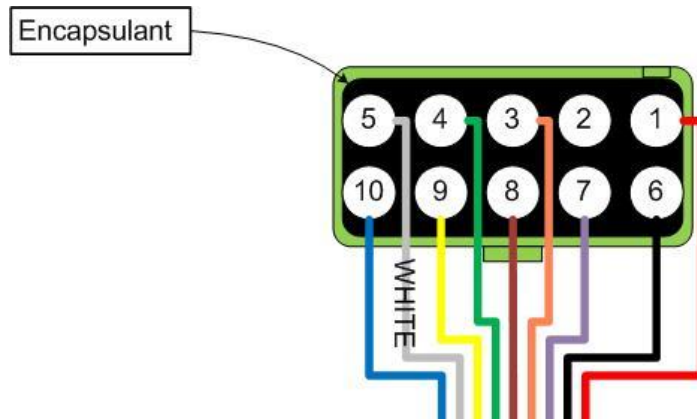

Figure 1 – IMU Connector Contact Pinout Arrangement

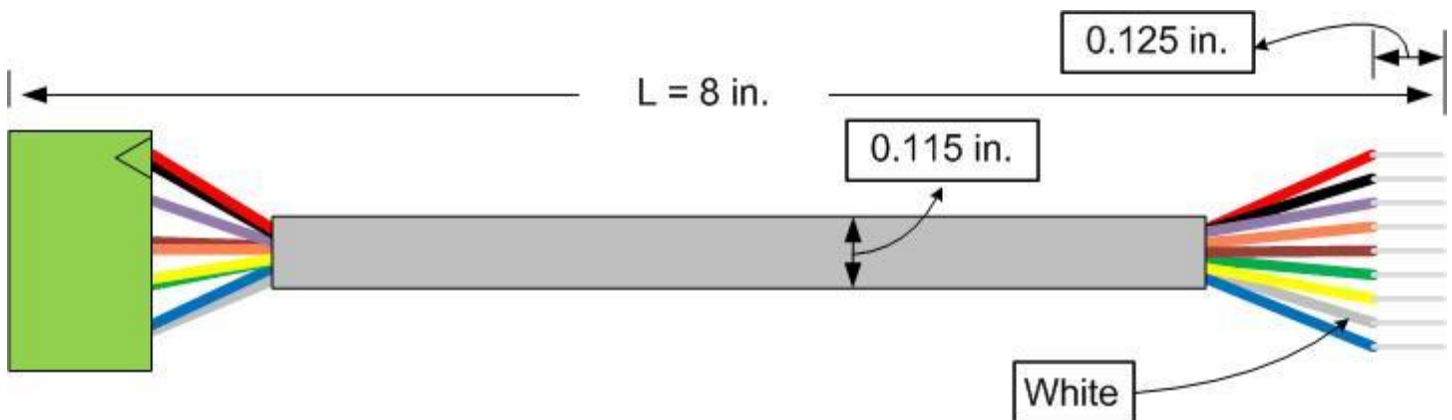

Figure 2 – Cable Overall Length Diagram